

Willoughby Stainless Fountains



WODF-1 Series Outdoor Drinking Fountain

Recommended Specifications

Willoughby Model **WODF-1** outdoor drinking fountain is a single-level, vandal resistant drinking fountain with Type 304 stainless steel 10" Schedule-10 main column and 7 GA. flange.

Fountain shall have a high-polished, 18 GA. stainless steel bowl with anti-rotation, anti-squirt, solid stainless steel bubbler. Bubbler shall be activated by a pedestal-mounted solid stainless steel push button assembly, which controls a lead-free, self-closing valve.

Push button shall require less than 5 lbs. of force to operate. Push button shall be adjustable to ensure adequate flow without being wasteful. **WODF-1** fountain shall be lead-free, adhering to ANSI/NSF 61, Section 9 requirements.

Fountain is available in an ADA configuration that shall meet American Disabilities Act of 2010 (ADA) compliance requirements; see option (HC) on the following page.

Optional mounting kit available for purchase consisting of stainless steel anchors, nuts, washers and rubber gasket washers. If optional kit is not used, stainless steel hardware recommended.

Standard Features

- * Heavy duty Type 304 stainless steel 10" Schedule-10 main column and 7 GA. flange
- * Optional marine-grade Type 316 stainless steel body for installations near salt water
- * High polished stainless steel bowl
- * Solid stainless steel, anti-rotation bubbler
- * Serviceable mesh strainer on inlet water supply
- * Heavy-duty main column access panel
- * Resistant to sunlight, heat and vandalism
- * Stainless steel adjustable push button
- * Powder coat finish (color options on page 2)

To specify fixture and color, use the Model Number and Options Guide.

Example: To specify a WODF-1 outdoor drinking fountain in Silver color

Use the following Willoughby Model Number: **WODF-1-SL**



WODF-1

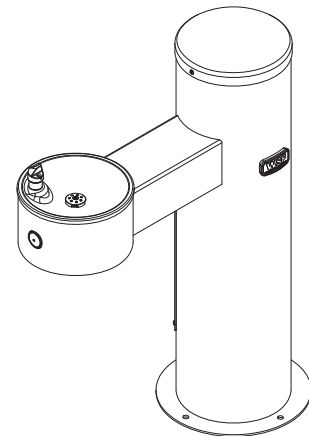

WODF-1-HC

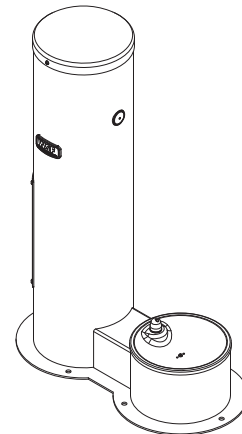

WODF-1-PET



WARNING: Cancer and Reproductive Harm

- www.P65Warnings.ca.gov

visit our website at www.willoughbystainlessfountains.com

5105 West 78th Street • Indianapolis, IN. 46268

(317) 875-0830 • Fax: (317) 875-0837 • (800) 428-4065



MADE IN THE U.S.A.

MODEL NUMBER AND OPTIONS:

1.) Outdoor Drinking Fountain Type:

- WODF-1 Single-bowl Outdoor Drinking Fountain

2.) Options:

- HC Adult ADA Compliant Single-bowl Fountain
 PET Pet Single-bowl Fountain
 316-1 316 Stainless Steel Body, Single
 CAR-10-1 Surface Carrier, Single (Including mounting hardware)
 CAR-10-2 Surface Carrier, Double (Including mounting hardware)
 SOV Shut Off Valve
 SCV Seasonal Bowl Cover (1)
 JF/FW Jug Filler / Foot Wash
 HBE Hose Bibb Exposed
 HBLD Recessed Hose Bibb w/ Lock Door
 HH Hose / Leash Hanger
 WSFMK4 4 Bolt Hole Mounting Kit (Not req'd with Carrier option)

3.) Colors (select one):

- SL Silver
 G Green
 R Red
 BL Blue
 O Orange
 V Violet
 Y Yellow
 BR Brown
 BK Black
 BE Beige
 W White
 YG Yellow Green
 LBL Light Blue
 GT Graphite (Textured)
 MTW Matte White

Approved For Manufacturing By: _____ Date: _____ Company: _____
 Wall Thickness: _____ Wall Type: _____

VERIFY ALL DIMENSIONS WITH FACTORY PRIOR TO ROUGH-IN
 WILLOUGHBY RESERVES THE RIGHT TO MAKE CHANGES IN DESIGN AND
 DIMENSIONS WITHOUT FORMAL NOTICE AND WITHOUT INCURRING OBLIGATION.

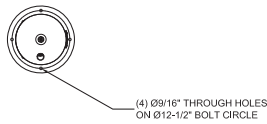
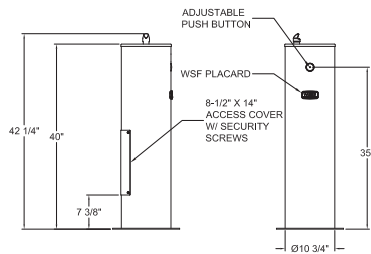

WODF-1

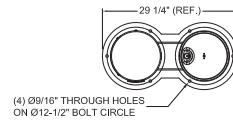
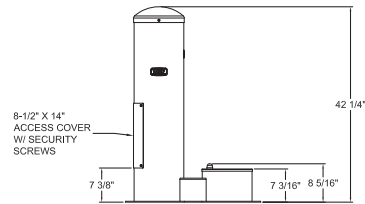

WODF-1-PET (PET OPTION)

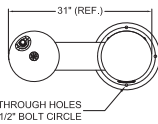
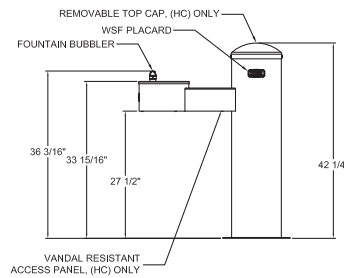

WODF-1-HC (ADA OPTION)

ADA COMPLIANCE
 FIXTURE COMPLIES WITH ADA ACCESSIBILITY REQUIREMENTS WHEN INSTALLED ACCORDING TO THE STANDARD. INSTALLATION MAY REQUIRE ADDITIONAL FIXTURES, COMPONENTS AND/OR CONSTRUCTION FEATURES TO BE FULLY COMPLIANT. CONSULT THE LOCAL CODE AUTHORITY IF NEEDED.

visit our website at www.wiloughbystainlessfountains.com

5105 West 78th Street • Indianapolis, IN. 46268
 (317) 875-0830 • Fax: (317) 875-0837 • (800) 428-4065



MADE IN THE U.S.A.