

Willoughby Stainless Fountains



WODF-3FA Series Outdoor Drinking Fountain Front Approach

Recommended Specifications

Willoughby Model **WODF-3FA** outdoor drinking fountain, front approach is a triple-level, vandal resistant drinking fountain with Type 304 stainless steel 10" Schedule-10 main column and 7 GA. flange.

Fountain shall have high-polished, 18 GA. stainless steel bowls with anti-rotation, anti-squirt, solid stainless steel bubblers. Bubblers shall be activated by pedestal mounted solid stainless steel push button assemblies, which control lead-free, self-closing valves.

Push buttons shall require less than 5 lbs. of force to operate. Push buttons shall be adjustable to ensure adequate flow without being wasteful. **WODF-3FA** fountain shall be lead-free, adhering to ANSI/NSF 61, Section 9, ANSIA117.1. Fixtures in (HC) and (CHD) configurations shall meet American Disabilities Act of 2010 (ADA) compliance requirements.

Optional mounting kit available for purchase consisting of stainless steel anchors, nuts, washers and rubber gasket washers. If optional kit is not used, stainless steel hardware recommended.

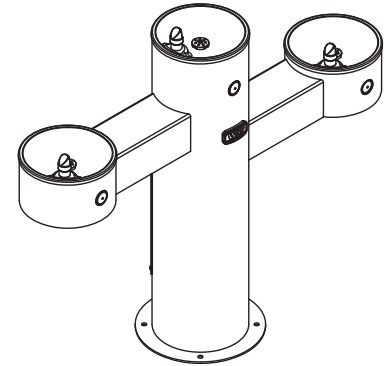

WODF-3FA-HC-CHD

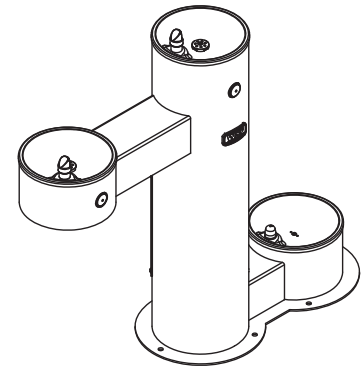

WODF-3FA-HC-PET
(SIDE PET LOCATION)

Standard Features

- * Adult ADA and Child (JR.) ADA compliant fixture configurations available
- * Heavy duty Type 304 stainless steel 10" Schedule-10 main column and 7 GA. flange
- * Optional marine-grade Type 316 stainless steel body for installations near salt water
- * High polished stainless steel bowls
- * Solid stainless steel, anti-rotation bubblers
- * Serviceable mesh strainer on inlet water supply
- * Heavy-duty main column access panel
- * Resistant to sunlight, heat and vandalism
- * Stainless steel adjustable push buttons
- * Powder coat finish (color options on page 2)

To specify fixture and color, use the Model Number and Options Guide.

Example: To specify a WODF-3FA outdoor drinking fountain with Adult ADA and Child-height (JR. ADA) bowls, in Red color

Use the following Willoughby Model Number: **WODF-3FA-HC-CHD-R**

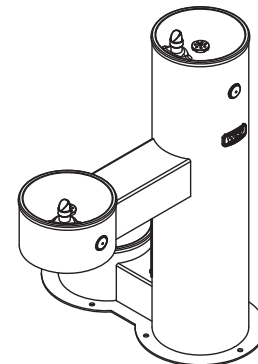

WODF-3FA-CHD-PET
(REAR PET LOCATION)



WARNING: Cancer and Reproductive Harm

- www.P65Warnings.ca.gov

visit our website at www.willoughbystainlessfountains.com

5105 West 78th Street • Indianapolis, IN. 46268
(317) 875-0830 • Fax: (317) 875-0837 • (800) 428-4065



MADE IN THE U.S.A.

MODEL NUMBER AND OPTIONS:

1.) Outdoor Drinking Fountain Type:

WODF-3FA Three-bowl Outdoor Drinking Fountain, Front Approach

2.) Bowl Height (other than main column bowl, select two):

HC Adult ADA Compliant
 CHD Child (JR. ADA Compliant)
 PET Pet Bowl
 Side Rear

3.) Options:

316-3 316 Stainless Steel Body, Triple
 CAR-10-1 Surface Carrier, Single (Including mounting hardware)
 CAR-10-2 Surface Carrier, Double, Used With Pet Bowl Only (Including mounting hardware)
 SOV Shut Off Valve
 SCV Seasonal Bowl Covers (3)
 JF/FW Jug Filler / Foot Wash
 HBE Hose Bibb Exposed
 HBLD Recessed Hose Bibb W/Lock Door
 HH Hose / Leash Hanger
 WSFMK4 4 Bolt Hole Mounting Kit (Not req'd with Carrier option)
 WSFMK6 6 Bolt Hole Mounting Kit, Used With Pet Bowl Only (Not req'd with Carrier option)

4.) Colors (select one):

SL Silver
 G Green
 R Red
 BL Blue
 O Orange
 V Violet
 Y Yellow
 BR Brown
 BK Black
 TBK Black (Textured)
 BE Beige
 W White
 YG Yellow Green
 LBL Light Blue
 GT Graphite (Textured)
 MTW Matte White

Approved For Manufacturing By: _____ Date: _____ Company: _____

Wall Thickness: _____ Wall Type: _____

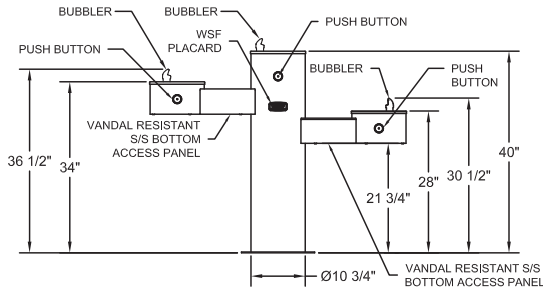

WODF-3FA-HC-CHD

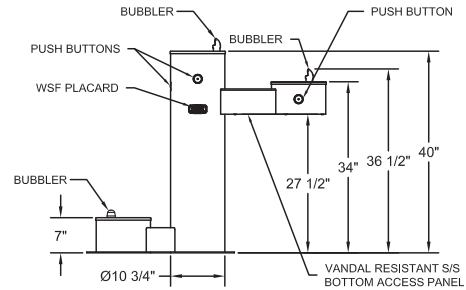

WODF-3FA-HC-PET

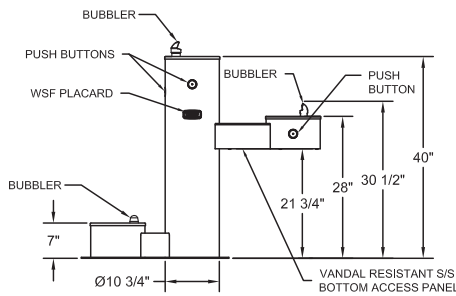

WODF-3FA-CHD-PET

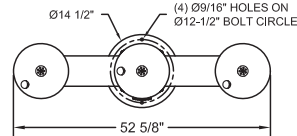

WODF-3FA-HC-CHD

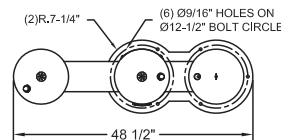

WODF-3FA-HC-PET & WODF-3FA-CHD-PET (SIDE PET LOCATION)

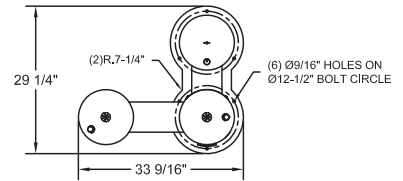

WODF-3FA-HC-PET & WODF-3FA-CHD-PET (REAR PET LOCATION)

Note: Access panel is on back side of unit.



ADA COMPLIANCE

FIXTURE COMPLIES WITH ADA ACCESSIBILITY REQUIREMENTS WHEN INSTALLED ACCORDING TO THE STANDARD. INSTALLATION MAY REQUIRE ADDITIONAL FIXTURES, COMPONENTS AND/OR CONSTRUCTION FEATURES TO BE FULLY COMPLAINT. CONSULT THE LOCAL CODE AUTHORITY IF NEEDED.

VERIFY ALL DIMENSIONS WITH FACTORY PRIOR TO ROUGH-IN
WILLOUGHBY RESERVES THE RIGHT TO MAKE CHANGES IN DESIGN AND DIMENSIONS WITHOUT FORMAL NOTICE AND WITHOUT INCURRING OBLIGATION.

visit our website at www.wiloughbystainlessfountains.com

5105 West 78th Street • Indianapolis, IN. 46268

(317) 875-0830 • Fax: (317) 875-0837 • (800) 428-4065



MADE IN THE U.S.A.

© Rev. 9/2024